

Operating Manual

Dust extractors

S2/S3 (230V)



Contents

1. Introduction	4
1.1. Owner responsibility	4
1.2. Copyright	4
1.3. Product description	4
1.4. Intended use	4
2. Product overview	5
2.1. Dust extractor S2	5
2.2. Dust extractor S3	5
3. Safety instructions and information	6
3.1. Safety definitions	6
3.2. General machine safety warnings	6
3.3. Electrical safety warnings	6
3.4. Safety warnings for assembly	6
3.5. Safety instructions for operation	7
3.6. Personal protective equipment	7
3.7. Work area safety	7
3.8. Safety instructions for maintenance	7
4. Assembly	7
4.1. General	7
4.2. To attach the nozzle on the hand pipe	7
5. Operation	8
5.1. Before use	8
5.2. Grounding instructions	8
5.3. To start and stop	8
5.4. Function	8
5.5. To assemble a new Longopac dust bag	8
5.6. To clean the filter	9
6. Maintenance	10
6.1. To clean the dust extractor	10
6.2. Filter change	11
6.2.1. To change the HEPA filter	11
6.2.2. To change the pre-filter	11

Contents

7. Troubleshooting	12
8. Transportation, storage and disposal	12
8.1. Transportation of the product	12
8.2. Storage of the product	12
8.3. Disposal of the product	12
9. Technical data	13
10. Warranty	14
11. EC Declaration of Conformity	15

1. Introduction

1.1. Owner responsibility

WARNING: Cutting, especially when dry cutting, generates dust that comes from the material being cut, which frequently contains silica. Silica is a basic component of sand, quartz, brick clay, granite and numerous other minerals and rocks. Exposure to excessive amount of such dust can cause:

- Respiratory disease (affecting your ability to breath), including chronic bronchitis, silicosis and pulmonary fibrosis from exposure to silica. These diseases may be fatal;
- Skin irritation and rash.
- Cancer according to NTP and IARC
- Take precautionary steps:
- Avoid inhalation of and skin contact with dust, mist and fumes.
- Wear and ensure that all bystanders wear appropriate respiratory protection such as dust masks designed to filter out microscopic particles.
- It is the owner's/employer's responsibility that the operator has sufficient knowledge about how to use the product safely.
- Supervisors and operators must have read and understood the
- Operator's Manual. They must be aware of:
- The products's safety instructions.
- The products's range of applications and limitations.
- How the product is to be used and maintained.

If you have any questions after reading this Operating Manual please get in touch with the manufacturer or the nearest service center. The manufacturer is not responsible for any damage or breakdown resulting from non-observance of the Operating Manual.

National/Local regulations could restrict the use of this product. Find out what regulations restrict the usage of the product before you start using that.

1.2. Copyright

The text and illustrations may not be copied or reproduced without the express permission of Vonarx.

1.3. Product description

The product is a single phase dust extractor, which separates the dust particles from the air. The particles fall into a plastic bag at the bottom of the product.

1.4. Intended use

The machine is designed for vacuuming and separating dry, non-combustible dust with an explosion limit value of $>0.1\text{mg/m}^3$. Do not use the product for other tasks.

This machine is intended for commercial use, for example in hotels, schools, hospitals, factories, shops, offices and rental businesses.

1.5. Caution

Read the instruction manual before using the machine!

2. Product overview

2.1. Dust extractor S2

- 1 Jetpuls Handle
- 2 Pre-filter
- 3 Blast gate
- 4 Longopac holder
- 5 Longopac connection
- 6 Hour meter
- 7 Lamp
- 8 Switch ON/OFF
- 9 HEPA filter
- 10 Toggle clamp
- 11 Manometer

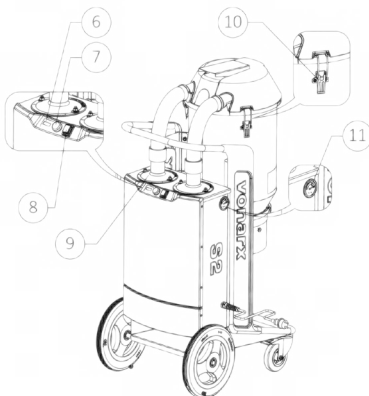
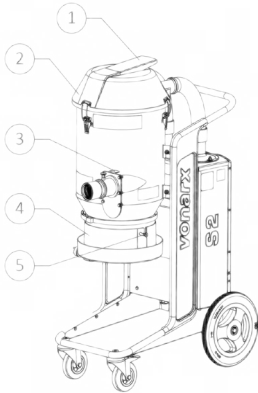

2.2. Dust extractor S3

- 1 Jetpuls Handle
- 2 Pre-filter
- 3 Blast gate
- 4 Longopac holder
- 5 Longopac connection
- 6 Hour meter
- 7 Lamp
- 8 Switch ON/OFF
- 9 HEPA filter
- 10 Toggle clamp
- 11 Manometer

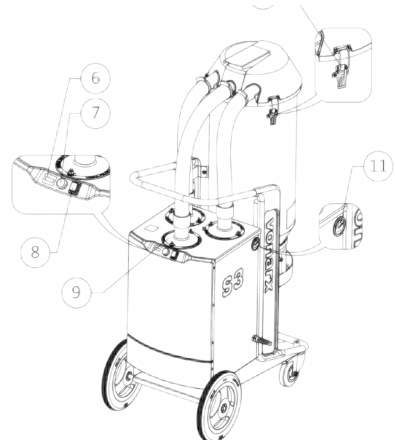
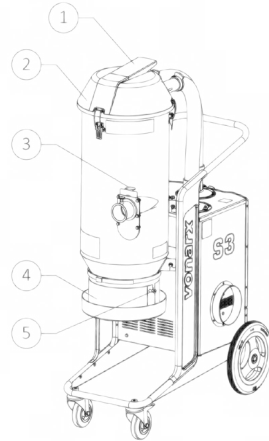



3. Safety instructions and information

3.1. Safety definitions

Warnings, cautions and notes are used to point out especially important parts of the manual.

 **WARNING:** Used if there is a risk of injury or death for the operator or bystanders if the instructions in the manual are not obeyed.

 **CAUTION:** Used if there is a risk of damage to the product, other materials or the adjacent area if the instructions in the manual are not obeyed.

 **NOTE:** Used to give more information that is necessary in a given situation.

3.2. General machine safety warnings

 **WARNING:** Read all safety warnings, instructions, illustrations and specifications provided with this machine.

- Failure to follow all instructions listed below may result in electric shock, fire and/or serious injury.
- Basic precautions should always be followed, including the followings:
 - Always exercise with care and use your common sense. If you get into a situation where you feel unsafe, stop and seek expert advice. Contact your dealer, service agent or an experienced user. Do not attempt any task that you feel unsure of!
 - Read the operator's manual carefully and use the machine only as described in this manual.
 - The product must be kept clean. Signs and stickers must be fully legible.
 - Do not allow it to use as a toy and do not play with the appliance. Close attention is necessary when used by or near children
 - This machine is not intended for use by persons (including children) with reduced physical, sensory or mental capabilities, or lack of experience and knowledge.
 - Operators shall be adequately instructed on the use of the machine.
 - Never use this product if you are fatigued, under the influence of alcohol or drugs, medication or anything that could affect your vision, alertness, coordination or judgment.
 - Do not handle plug or machine with wet hands.
 - Never use a product that is faulty. Carry out the safety checks, maintenance and service instructions described in this manual. Some maintenance and service measures must be carried out by trained and qualified specialists.

3.3. Electrical safety warnings

- Before using the machine, make sure that the power & voltage corresponds with the voltage shown on the machine's rating plate.
- Use only manufacturer's recommended attachments.
- Using damaged cables can be dangerous and should be replaced immediately.
- Make sure the assembly area is firm, so the dust extractor does not tip over.
- Improper connection of the equipment-grounding conductor can result in a risk of electrical shock. Check with a qualified electrician or service person if you are in doubt whether the outlet is properly grounded. Do not modify the plug provided with the machine. If it will not fit the outlet, have a proper outlet installed by a qualified electrician.
- If using an extension cord make sure the cord rating is suitable for this machine.
- Do not use the machine with damaged cord or plug. If the machine is not working as it should, it has been dropped, damaged, left outdoors or dropped in water. Make sure it is repaired by a qualified person.
- Regularly inspect the cord and plug for damage. Do not use it with a damaged cord or plug.
- Do not pull or carry by cord, use cord as handle, close a door on cord, or pull cord around sharp edges or corners. Do not run the machine over the cord. Keep cord away from heated surfaces.
- Do not unplug by pulling on cord. To unplug, grasp the plug. Not the cord.
- Do not leave the machine when plugged in. Unplug cord from outlet when not in use and before cleaning or servicing the machine.

3.4. Safety warnings for assembly

- Turn off all controls before unplugging.
- Unauthorized modifications and /or accessories may lead to serious injury or death to the user or others.
- Use only attachments as described in this manual.
- Make sure that the assembly area is firm, so the product does not tip over.
- Risk of personal and material injury.
- Be careful, the toggle clamps can cause damage to the operator when assembling the product.

3. Safety instructions and information

3.5. Safety instructions for operation

- Do not use the machine outdoors or on a wet surface. This machine is suitable for indoor and dry use only.
- Do not pick up anything that is burning or smoking, such as cigarettes, matches or hot ashes.
- Do not use it to pick up flammable or combustible liquids, such as gasoline, or use in areas where they may be present.
- This machine is designed for picking up dry, nonflammable dust and debris in an indoor environment.
- Do not pick up any type of liquids.
- Do not put any object into openings. Do not use with any opening blocked (except during filter cleaning procedure). Keep free of dust, hair and anything that may reduce airflow.
- Keep hair, loose clothing, fingers and all parts of the body away from openings and moving parts.
- Use extra care when cleaning on stairs.
- Do not use the product without a dust bag and/ or filters in place. Replace collection system and/or filters as described in this manual.

3.6. Personal protective equipment

- Do not use it to pick up flammable or combustible liquids, such as gasoline, or use in areas where they may be present.
- Always use approved personal protective equipment during operation. Personal protective equipment does not give you full protection but it decreases the degree of injury if an accident occurs.
- Use approved protective gloves when you maintain the product.

3.7. Work area safety

- Do not expose the product to rain and moisture.
- Do not operate machines in explosive atmospheres, such as in the presence of flammable liquids, gasses or dust.



WARNING: This machine is for dry use only.



CAUTION: This machine is for indoor use only. Do not store the machine outdoors or on a wet surface.

3.8. Safety instructions for maintenance

- Make sure the engine switch is in the OFF position.
- Disconnect the product from the wall outlet.
- Do not modify the product from its original design.
- All repairs must be performed by a qualified service person. Use only manufacturer-supplied or equivalent replacement parts.
- Use approved protective equipment.
- Do not make a hole in the HEPA filter. A broken HEPA filter can disperse dust.



WARNING: This machine contains dust hazardous to health. Emptying and maintenance operations, including removal of the dust collection means, must only be carried out by authorised personnel wearing suitable personal protection. Do not operate without the full filtration system fitted.

4. Assembly

4.1. General

When unpacking the machine, do a check that the following accessories are included:

- Hose
- Steel tube
- Floor tool
- Air duct adapter
- Connector

If any of the above-mentioned parts are missing, please contact your local distributor or our sales representative.

Please dispose of packaging materials and used machine components in an environmentally safe way according to local disposal regulations. Always remember to recycle.

4.2. To attach the nozzle on the hand pipe

The floor nozzle has adjustable wheels. Adjust the wheels to get the best suction effect. Adjust the wheels with the knob, which is on the rear side of the nozzle.

The wheels and rubber strips of the nozzle can be replaced. Keep the nozzle in good condition.

5. Operation

5.1. Before use

WARNING: Before using the dust extractor make sure that the power and voltage corresponds with the voltage shown on the machines rating plate, including extension cords.

5.2. Grounding instructions

WARNING: The dust extractor must be grounded. If it should malfunction or break down, grounding provides a path of least resistance for electric current to reduce the risk of electric shock. The dust extractor is equipped with a cord having an equipment-grounding conductor and grounding plug. The plug must be inserted into an appropriate outlet that is properly installed and grounded in accordance with all local codes and ordinances.

5.3. To start and stop

Use the switch to start the dust extractor.



0: Motor OFF

1: Motor ON

5.4. Function

The machine is designed for vacuuming and separating dry, non-combustible dust with an explosion limit value of $>0.1\text{mg/m}^3$.

The dust extractor is started by the switch.

Dust-laden air is then sucked through the inlet valve at high speed via the suction hose. The air is slowed down by the cyclone and coarse dust particles are separated out, partly by centrifugal force and partly by gravity.

Air and finer particles then pass through the double filter system where separation is made. The machine is designed for filter cleaning by reverse air pulse. The separated dust accumulates in the cyclone until the machine is switched off, when it drops through the bottom flap into the plastic bag.

The filter cleaning process is not completed before it is clear that the dust inside the tank has fallen down into the collection bag. In some extreme cases the adhesive ability of the dust must be broken manually. This can be done by hitting the dust through the bag or tapping the tank using i.e. a rubber hammer.

5.5. To assemble a new Longopac dust bag

WARNING: Always clean the prefilter before change of bag collection system.

NOTE: The dust extractor has Longopac system.

1 Put the dust bag in the holder.

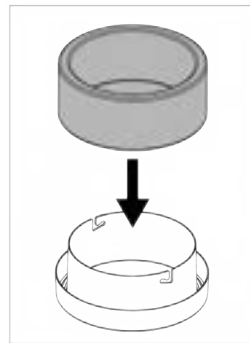

- 2 Attach the dust bag holder to the container by twisting it on to the holding pins.
- 3 Pull the bag up from the bag holder and put it around the container.

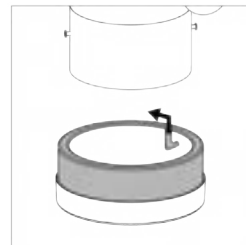

5. Operation

4. Tighten a strap around the bag and the container to secure the bag to the container.



5. Pull the dust bag over the bag holder and close the bottom of the dust bag with a cable tie.



Cleaning procedure:

- 1 While running the dust extractor, seal the inlet by closing that with the blast gate.
- 2 Let the dust extractor build up vacuum for 5 seconds, then quickly push and hold down the jetpuls handle for 5 seconds.
- 3 Repeat the previous step five times. It is important to let the dust extractor rebuild the vacuum in between every repetition.
- 4 If suction remains poor, the filter should be replaced. Replace the plastic bag only after cleaning the filter

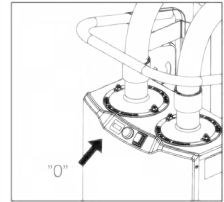
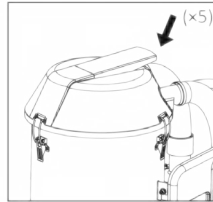
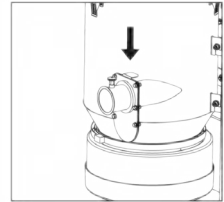
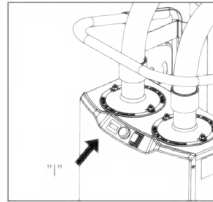

5.6. To clean the filter

CAUTION: If suction remains poor, the prefilter needs to be replaced. If suction still remains poor afterwards, the HEPA filters need to be replaced. See instructions *in chapter 6.2.1*.

The filter must be cleaned from time to time. This must be done before changing the plastic bag collection system and should also be done when work is completed or when there is poor suction.

6. Maintenance

WARNING

- Use personal safety equipment during service. Refer to Personal protective equipment in *chapter 3.6*. Dust can be exposed during maintenance and service.
- Most accidents involving machines occur during troubleshooting, service and maintenance as staff have to locate themselves within the risk area of the machine. Prevent accidents by being alert and by planning and preparing the work.
- The engine should be switched off during operations described in this chapter unless otherwise stated.
- All checks involving electric components should only be performed by a licensed electrician.

Maintenance schedule

Maintenance	Before each use	Daily	Weekly	When suction is low	6 months or 1000h	12 months or 2000h
Look for signs of wear, damage or loose connections of the controls before the unit is connected.	X					
Do a check that the dust bag/Longopac is correct		X				
Do a check of the filter cleaning mechanism.		X				
Do a check of the wheels. Look for damaged and bad connections.			X			
Clean the pre-filter.				X		
Replace the pre-filter.					X	
Replace the HEPA filter.				X		X

6.1. To clean the dust extractor

It is important to clean the dust extractor to prevent circulation of dangerous dust. Always clean the dust extractor before it is moved from the work area.

 **WARNING:** Turn the motor switch to its OFF position and disconnect the cord from the wall outlet before you clean or do maintenance to the product.

- All equipment once used must be regarded as contaminated and be treated thereafter.
- All parts that are contaminated after service work must be properly disposed in plastic bags according to the local regulations.

- Use proper personal equipment when you clean the product. Dust can be spread when the coarse filter and the absolute filter are replaced that can be hazardous to health. Accordingly, the user should wear protective glasses, protective gloves, and a breathing mask conforming to protection class FFP3.
- Clean the external surface with a moist cloth.
- Clean the filters and the dust extractor in applicable area.
- Vacuum the pre-filter from the outside. Always use dust extractors with HEPA-filter and a soft brush to not damage the filter.
- Do not use water on electrical components.
- Do not clean the dust extractor with high pressure (air or water).
- Do not put tools on the surface of the filter, it can cause damage to the filter.
- Do not make a hole in the HEPA filter, it can cause a health risk.

6. Maintenance

6.2. Filter change

WARNING: Use personal safety equipment, during filter change, because dust can be spread.

Refer to Personal protective equipment in *chapter 3.6*.

WARNING: Always turn the motor switch in the OFF position and disconnect the cord from the wall outlet during filter change.

6.2.1. To change the HEPA filter

 **CAUTION:** Do not clean HEPA filters. Trying to clean a HEPA filter will destroy it. When installing the replacement filter, make sure to not touch the inside of the filter. Any kind of force/damage on the inside of filter media will destroy the new filter.

 **NOTE:** Recommended intervals for filter change: Prefilter every 6 months and HEPA filters every 12 months.

- 1 Loosen the nuts on each filter cover cap.
- 2 Carefully lift the filter into a clean plastic bag, use the bag from the new filter. This bag must be properly disposed.
- 3 Insert a new filter in reverse order.

6.2.2. To change the pre-filter

 **CAUTION:** When you remove the pre-filter in order to clean it, use only low pressure water from the inside through to the out. Hitting the filter with force, high pressure water or use of compressed air will destroy the filter. The filter must be 100% dry before returning into the housing.

- 1 Loosen the 3 toggle clamps and remove the top.
- 2 Take the bag from the new filter.
- 3 Lift out the filter and place it gently in a plastic bag. This bag must be properly disposed.
- 4 Insert a new filter.

7. Troubleshooting

Issue	Cause	Solution
Motor does not start	No power	Plug in the machine
	Defective cable	Replace cable
	Defective switch	Replace switch
	Defective soft starter	Replace soft starter
Motor stops immediately after starting	Wrong fuse	Connect to correct fuse
	Shortcut in cable/machine	Order service
Motor runs but there is no suction	Hose not connected	Connect hose
	Hose blocked	Clean hose
	No dust collection bag	Fit dust collection system
Motor runs but there is poor suction	Hole in hose	Replace hose
	Filter clogged	Clean filter/Replace filter
	Loose top cover	Adjust
	Dirt in the flap	Clean the flap
	Defective gaskets	Replace affected gaskets
Dust blown from motor	Wrongly assembled or damaged filter system	Adjust/Replace filters
Abnormal noise		Order service

8. Transportation, storage and disposal

8.1. Transportation of the product

- Before the transportation make sure that the Longopac bag is empty
- During the transportation Make sure that the Longopac bag is attached to the product
- Use ramps or winches to lift the dust extractor to make sure that movements are safe. Get aid if you are not sure about how to lift heavy equipment.
- Attach the product safely during transportation in order to prevent transport damage and accidents.
- Engage the locking caster safely on the wheels.
- If possible, do the transportation of the product during good weather conditions.
- If possible, use a closed vehicle during transportation of the product.

8.2. Storage of the product

- The product must be stored inside away from outdoor elements.
- Do not expose the product to rain or moisture.
- Attach the locking casters safely.
- Disconnect the product from the power source.
- Store the product and the equipment in a dry area with no frost or excessive heat.
- Store all equipment in a locked area, so that it is out of reach of children and unauthorized persons.

8.3. Disposal of the product

- Obey the local recycling requirements and applicable regulations.
- When the product no longer is used, send it to the dealer or discard it at a recycling location.

9. Technical data

Data	S2 (220-230V)	S3 (220-230V)
Rated Voltage (1 phase), V	220-230	220-230
Frequency, Hz	50-60	50-60
Power (max), HP (kW)	3.2 (2.4)	4.8 (3.6)
Current (max),A	12	18
Airflow (max), cfm (m ³ /h)	236 (400)	353 (600)
Vacuum (max), psi (kPa)	24 (3,5)	24 (3,5)
Main hose length, m	7.5	7.5
Main hose diameter, mm	50	50
Auxiliary outlet	No	No
Max load Auxiliary outlet, W	N/A	N/A
Pre-filter, % at 1µm	99.95	99.95
Pre-filter area, ft ² (m ²)	32 (3)	48 (4.5)
HEPA filter 99,99% at 0.3 µm	2	3
Total HEPA filter area, ft ² (m ²)	26 (2.4)	39 (3.6)
Dust collection system, type	Longopac	Longopac
Filter Cleaning Mechanism	Jetpuls	Jetpuls
Dimensions (L×W×H), mm	786×543×1284	926×544×1512
Weight, kg	68	75
Sound power level LWA measured, dB(A) ¹		
Sound pressure level LPA at the operators ear, dB(A) ²		
Vibration level ah, (m/s ²) ³	< 2,5	

1: Noise emissions in the environment measured as sound power (LWA) in conformity with EN 60335-2-69. Uncertainty Kwa 2dB.

2: Noise pressure level according to EN 60335-2-69. Uncertainty KPA 2dB.

3: Vibration level according to EN 60335-2-69. Reported data for vibration level has a typical statistical dispersion (standard deviation) of 1 m/s².

10. Warranty

Vonarx guarantees perfect operation of the unit in normal service for a period of one (1) year from the date of purchase by the original consumer purchaser. Component manufacturers offer separate warranty periods. Call Technical Services at +359 32 94 05 53 for complete information.

Vonarx checks all units to ensure they are complete and operating correctly before they leave the works.

The customer must check the machine for any defects or damage in transit immediately on receipt and must inform the sales center and the forwarding agent of any damage or defect without delay.

This warranty does not apply to defects caused by damage, unreasonable use, faulty repairs made by others or defects caused by failure to provide reasonable maintenance, while in the possession of the consumer. Further, the warranty is void if the product, or any of its components, is altered or modified by the consumer or if the product is used in an inappropriate manner or with a blade not recommended by the manufacturer.

In addition, no claim can be considered under the warranty if any parts other than those manufactured or recommended by Vonarx are used.

Wear items are not covered under warranty:

- Castors
- Filters
- Wheels
- Wear pads
- Spark plugs

11. EC Declaration of Conformity

In accordance with the EC Machinery Directive 2006/42/EC:

We hereby declare that the equipment described below including its concept, construction and design as marketed by our company complies with the relevant fundamental safety and health requirements of the EC directive. This declaration becomes invalid on any unauthorized modification of the equipment.

Applied Standards

EN ISO 12100:2011

EN 60204-1:2019

Designation of the units

Dust extractor

Type

Vonarx S2/S3 (220- 230V)

Country of origin

Bulgaria

A handwritten signature in blue ink, appearing to read 'Torbjörn Bengtsson'.

Torbjörn Bengtsson
MBD

Plovdiv, 11 01 23

Responsible for documentation

Benny Aronsson, CEO



Manufacturer

Von Arx EOOD
Nedyalka Shileva 20
4000 Plovdiv, Bulgaria

Email: order@vonarx.com
www.vonarx.com

Tel: +359 32 94 05 53

