

NUMBER	200600760a
MODEL	C3000
REV.	A-01

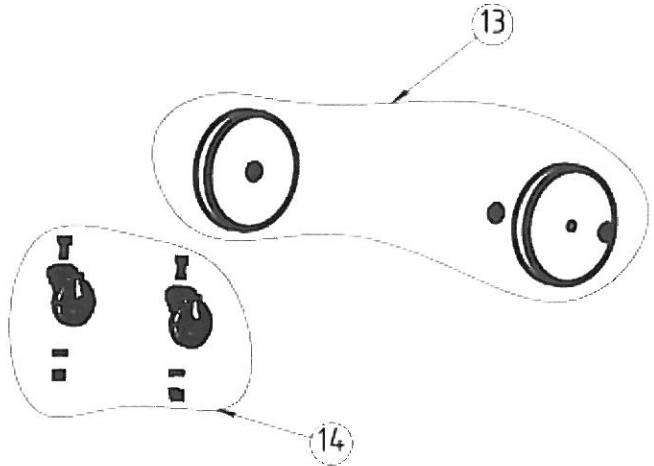
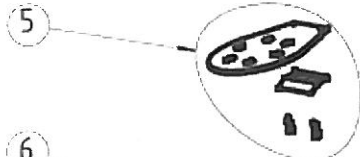
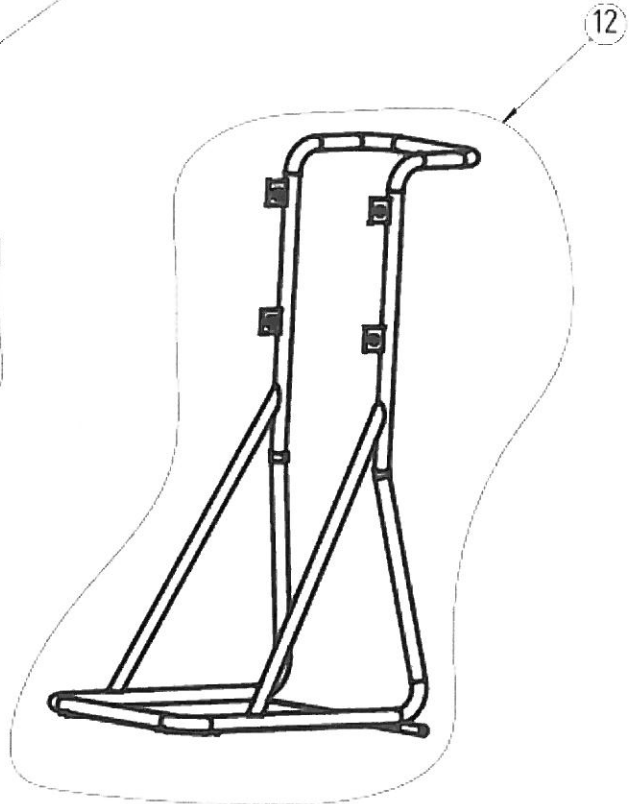
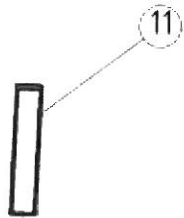
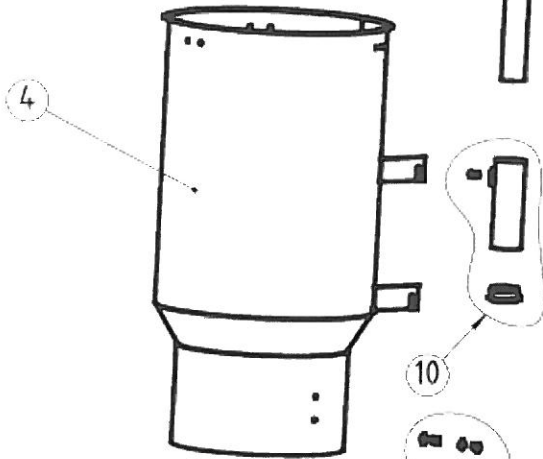
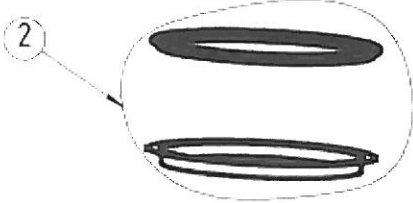
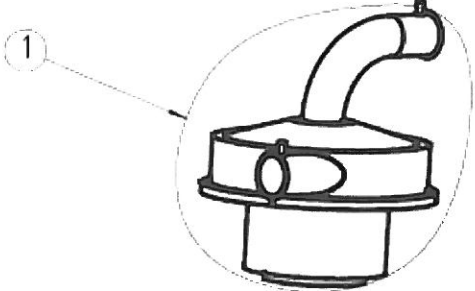

C-3000

No.	Qty.	Part No.	Decription
1	1	201100474a	PRE-SEPARATOR TOP COVER 63 mm S-LINE INLET KIT (ex. C3000)
2	1	201100475	INNER RING + SEALING KIT (ex. C3000)
3	3	200600799	TOP COVER HOLDER KIT
4	1	201100476	TANK KIT (ex. C3000)
5	1	201000116	FLAP KIT
6	1	201100140	BELT KIT
7	1	201100141	ANTI-SKID KIT
8	1	1376013	LONGOPAC KIT (4 PCS)
9	1	201100135	LONGOPAC HOLDER KIT
10	1	200800153	CLIP HOLDER KIT
11	1	N/A	
12	1	201100477	WAGON COMPLETE (ex. C3000 INCL. WHEELS)
13	1	201100479	REAR WHEEL KIT (ex. C3000)
14	1	201100478	FRONT WHEEL KIT (ex. C3000)
15	1	201100480	TANK ASSMEBLY SCREW KIT (ex. C3000)